

Wound Component EST Scanner



WOUND COMPONENT EST SCANNER MODEL 19035 SERIES

Wound Component Testing Solution

The quality verification tests of wound components consist of AC/DC Hipot tests, Insulation Resistance (IR) tests and Impulse Winding tests. Chroma integrates the above tests into 19035 Wound Component EST Scanner Series to perform safety tests for motor, transformer, and heater related wound products. Not only reliable quality but also efficient product control would be obtained when implementing it to quality verification by wound component manufacturers.

Chroma 19035 Series support 5kVac/6kVdc high voltage output to conform with withstand voltage test requirement for wound components, and its maximum output current is up to 30mA. The Insulation Resistance (IR) test measurement ranges from $1M\Omega$ to $50G\Omega$ and voltage output can be up to 5kV; while the DCR test can measure the resistance parameter of wound components and test the circuit connection (contact check) before withstand voltage test.

The 19035 Series also have powerful functions in Flashover detection, Open/Short Check (OSC) as well as programmable voltage and time parameters for various characteristics of DUTs to increase testing reliability and product quality.

Applications

The 19035 Series is a comprehensive safety tester designed for motor, transformer, and heat related wound component tests. Most of wound components have multiple windings, such as 3-phase motors and dual winding transformers. In addition, the wound components for high voltage winding need to be tested with Impulse Winding Tester to check the insulation ability of windings.

The 19035 Series can be connected to DWX Series-Impulse Winding Tester directly, and its 8-Channel scanning can measure multiple test points in one test instead of switching test points manually. It saves the test time and labor cost greatly.

The equipped OSC and DCR functions verify poor contact or short circuits occurred during test and solve the contact problem of wound components to improve the test quality and prolong test equipments.

- ◆ Motor, Fan : 19035-M / 19035-ML
- ◆ Electric Heater Tube : 19035-M / 19035-ML
- ◆ Transformer : 19035/ 19035-L
- ◆ Switch, Wire : 19035 / 19035L
- ◆ Camera Micro Motor, Coil : 19035-S

MODEL 19035
19035-M
19035-ML
19035-L
19035-S

Functions :

- 5kVAC & 6kVDC Hipot Test
- $1M\Omega \sim 50G\Omega$ /5kV IR Test
- $10m\Omega \sim 100k\Omega$ DCR Test
- DWX Series - Impulse winding tester could be connected
- 8 channel scanner

Key Features :

- Support 16CH scan box (19035 only)
- SUB-STEP function
- Open / Short Check (OSC)
- GFI human protection
- Flashover detection
- Key lock function
- RS232 Interface (standard*1)
- GPIB & HANDLER (optional)
- CE mark



Chroma

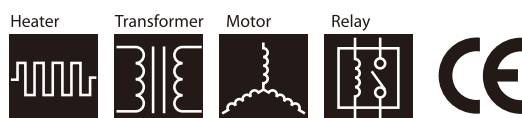

FLASHOVER DETECTION

Chroma 19035 has flashover detection as other Chroma EST testers. Flashover is the electrical discharge generated by high electric field inside or on the surface of insulation material that makes the DUT to lose its insulation characteristic and form a transient or discontinuous discharge. It can cause a carbonized conductive path or damage the product under test. Flashover cannot be detected by monitoring leakage current only. The change rates of test voltage or leakage current are monitored to detect flashover as its detection is one of the most indispensable test items for electrical safety test.

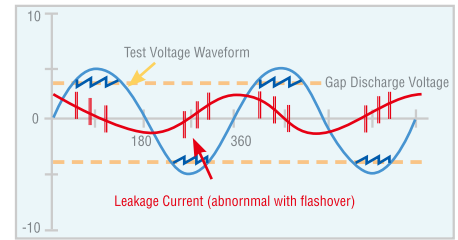

GROUND FAULT INTERRUPT (GFI)

The requirement of test environment indicates that test equipment should be equipped with auto interrupt device, thus Chroma develops a function of Ground Fault Interrupt (GFI) to protect the user. When the current difference i_H ($i_1 - i_2$) between i_1 and i_2 detected by current meters A_1 and A_2 is too high, the GFI device will immediately cut off the power supply to protect the human body from electrical shock. GFI is not only compliant to the safety standards but also a safeguard for operating personnel.

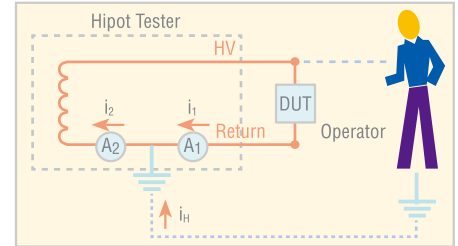

OPEN / SHORT CHECK (OSC)

OSC function can check if there is any Open (bad connection) or Short (DUT short circuited) occurred during test. If a DUT is open circuit during test, the unit might be misjudged as a good one. If a DUT has short circuit, OSC function can filter it out to diminish the damage to fixture and save the test cost.

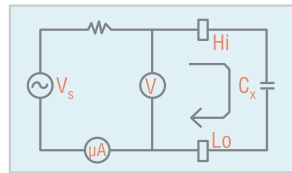

Normal Condition

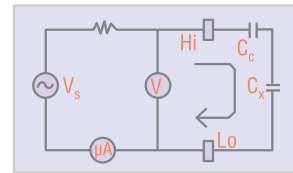

If Circuit opened :
 $C_m = C_c + C_x / (C_c + C_x) \ll C_x$

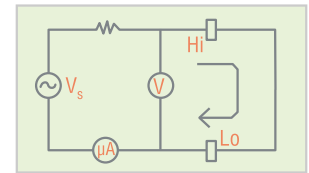

If circuit shorted : $C_m \gg C_x$

In general, products under Hi-pot test have capacitance (C_x). C_x could be tens of pF to several μF in normal condition. When the circuit connection is interrupted, a small capacitance will be formed on the broken interface that is usually lower than 10pF. It makes the entire capacitance of the product lower than normal value. The capacitance of a product may be higher than normal when the product is short-circuited or near short circuit. Thus the high/low limit of capacitance variation can be used to identify the short circuit problem.

HIGH SPEED CONTACT CHECK(HSCC)

HSCC mode is a new measurement technology for contact check. It can scan the circuit contact of multiple test points in a very short of period. With this new feature, contact check before Hipot test can be done quickly.

IMPULSE WINDING TEST

DWX Series provides Impulse Winding Test which exerts a transient high voltage on a winding and examines the status inside it based on the oscillation and attenuation of waveform. The winding status under examination includes insulation degree, winding inductance, shunt capacitance and etc. For more detail information, please refer to the application and technical notes of Chroma DWX Series. Chroma 19035 can connect DWX Series directly, and with programmable test sequences and 8-channel scan ports, the Impulse Winding Test is aimed to multi-pin scan test for motors, transformers, and wound related products.

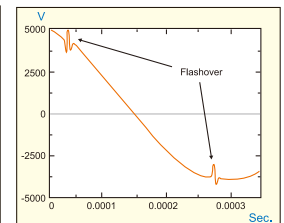
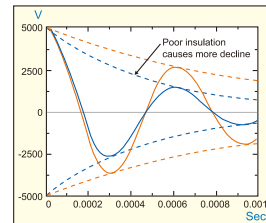

DWX Series Impulse Winding Testers have large TFT LCD for observation of winding insulation failure waveform. The figure on the left shows the winding insulation failure detected by area decreasing rate. The figure on the right shows the flashover detected by Laplacian.

DCR MEASUREMENT 2W/4W

DCR measurement for two-wire/four-wire is one of the standard test item. The two-wire measurement is suitable for major DCR, whereas the four-wire measurement is suitable for minor DCR since it has higher accuracy.

Temp Compensation

The problem caused by temp difference will be occurred usually as measuring minor DCR value. When the temp difference and the measured resistance value will be different. The Temp Compensation function is added to the 19035, the DCR converted to the measured value under standard temp via temp coefficient conversion. Thus, the measured difference generated by temp difference would be reduced.

DCR Balance

The DCR value is commonly related to inductance balance. When the DCR of three sets of wound motor unbalance will cause the rotation unbalance as well as bad quality after long time use. The DCR balance judgment subtracts the minimum value from maximum value of winding, if the value over setting range i. e. no good product. The DCR Balance function will be the auxiliary tool for motor products in long-term reliability testing.

Contact Check

DCR test not only measure the resistance of winding, but also check the connecting before Hipot test. Chroma 19035 can perform the DCR measurement on windings to check external contact, especially for the capacitance lower than 20 pF between the test points in wound component.

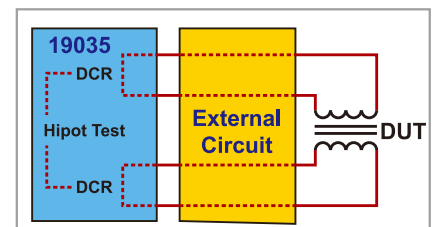

APPLICATIONS

MOTOR/DC FAN SEMI-FINISHED PRODUCTS ELECTRICAL TESTING

Motor, DC fan and semi-finished products of electrical rotating machine including stator and rotor require Hipot, DC resistance and layer short tests.

Chroma 19035-M can offer four-wire DCR measurement without computer control. The user can scan test two DUTs at a time by 8 test terminals which have separated Drive and Sense terminals to increase productivities.

CH 1, 2, 3, 5, 6, 7 can be set High/Off
CH 4, 8, can be set Low/Off

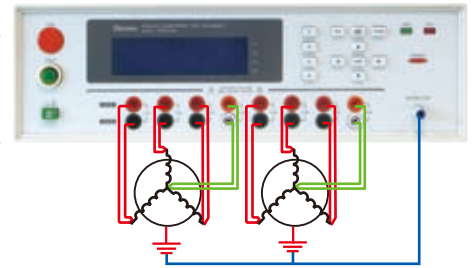

SUB-STEP FUNCTION FOR MULTI-UUT TESTING

Parallel test is often used as a solution to enhance the efficiency of withstand voltage test during production. However, if current high/low limit is not set correctly, defect products may be released, or good products may be misjudged as defect and then send to the subsequent stations for retest.

In order to solve the parallel test problem and reduce the number of stations and cost, 19035 Series provides Sub-Step function. The fail condition can be set as Sub-Step activation condition by editing the program sequence when parallel test is required for production. It means the Sub-Step test will be conducted only when the main test item (parallel) failed and it will find out which DUT is faulty. With the implementation of this function, the efficiency of withstand voltage test is improved significantly on the production line.

Example:

STEP 1: AC Hipot / pin1 to pin5, 6, 7

Sub step A: AC Hipot / pin1 to pin5

Sub step B: AC Hipot / pin1 to pin6

Sub step C: AC Hipot / pin1 to pin7

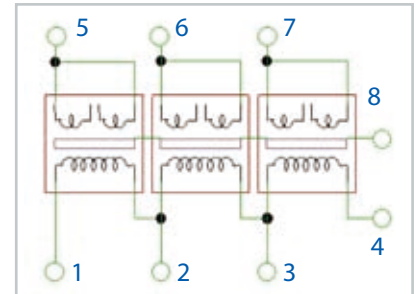

40-CHANNEL SCAN FOR WOUND COMPONENT HIPOT TEST

The new option A190359 16CH HV External Scanning Box has 16 test channels, and each channel can be set as H (High Voltage Output), L (Return Low), or Off. The combination of 19035 and A190359 can improve the efficiency of wound component tests. With two units of A190359 and one 19035, the test channels can up to 40, also the contact check and test of multi-pin components or products can be done at once.

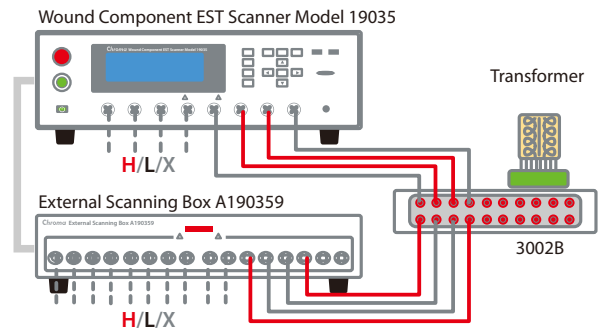

PANEL DESCRIPTION

19035 / 19035-S

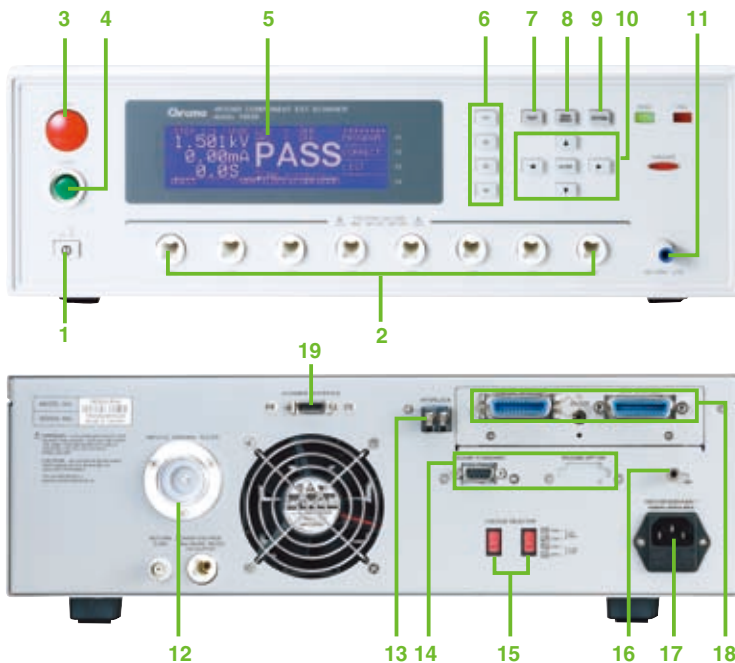

1. Power switch
2. Unknown test terminal
3. Stop key
4. Start key
5. LCD panel
6. Function keys
7. Test key
8. Main index key
9. System key
10. Cursor keys and enter key
11. Ground terminal
12. IWT connector (optional)
13. Interlock
14. RS232 interface (standard*1, option*1)
15. Line voltage selector
16. Ground terminal
17. AC line input
18. GPIB/HANDLER/TEMP interface (optional)
19. Scan Interface

19035-M



19035-ML



19035-L



SPECIFICATIONS

Model	19035	19035-L	19035-M	19035-ML	19035-S
Mode	ACV / DCV / IR / DCR -8CH / IWT	ACV / DCV / IR / DCR -8CH / IWT	ACV / DCV / IR / DCR -8CH / IWT	ACV / DCV / IR / DCR -8CH / IWT	ACV / DCR -8CH
Impulse Winding Test (Layer Short, IWT)	External option	Internal standard	External option	Internal standard	-
Channel Programming	H/L/X in 8CHs	H/L/X in 8CHs	H/X in CH 1,2,3,5,6,7 L/X in CH 4,8	H/X in CH 1,2,3,5,6,7 L/X in CH 4,8	H/L/X in 8CHs
Withstanding Voltage Test					
Output Voltage	AC:0.05 ~ 5kV, DC : 0.05 ~ 6kV				
Load Regulation	1% of setting + 0.1% of full scale.				
Voltage Resolution	2V				
Voltage Accuracy	1% of setting + 0.1% of full scale.				
Cutoff Current	AC : 30mA, DC : 10mA				
Current Resolution	AC : 1 μ A, DC : 0.1 μ A				
Current Accuracy	1% of reading + 0.5% of range. (Real current : 1% of reading + 5% of total current)				
Output Frequency	50Hz / 60Hz				
Test / Ramp / Fall / Dwell Time	0.3 ~ 999 sec., continue / 0.1 ~ 999 sec., off / 0.1 ~ 999 sec., off / 0.1 ~ 999 sec., off				
Waveform	Sine wave				
Insulation Resistance Test					
Output Voltage	DC : 0.05 ~ 5kV				
Voltage Resolution	2V				
Voltage Accuracy	1% of setting + 0.1% of full range				
IR Range	1M Ω ~ 50G Ω				
Resistance Resolution	0.1M Ω				
Resistance Accuracy	$\geq 1000V$	0.1M Ω ~ 1G Ω : \pm (3% of reading + 0.1% of full range) 1G Ω ~ 10G Ω : \pm (7% of reading + 2% of full range) 10G Ω ~ 50G Ω : \pm (10% of reading + 1% of full range)			
	500V~1000V	0.1M Ω ~ 1G Ω : \pm (3% of reading + 0.1% of full range) 1G Ω ~ 10G Ω : \pm (7% of reading + 2% of full range) 10G Ω ~ 50G Ω : \pm (10% of reading + 1% of full range)			
	$\leq 500V$	0.1M Ω ~ 1G Ω : \pm 3% of reading + (0.2*500/Vs)% of full scale			
Scanner Unit	8 ports, \pm phase (4W DCR only 4 ports)				
DC Resistance Measurement					
Test Signal	<DC 10V. < DC 140mA				
Measurement mode	2 terminals (2W) / 4 terminals(4W) measurement selectable ; Range 10m Ω ~ 500k Ω				
Measurement Accuracy (2W/ 4W)	1 Ω (4W only)	-- / \pm (0.5% of reading + 0.5% of range)			
	10 Ω	\pm (2% of reading + 0.5% of range) / \pm (0.5% of reading + 0.05% of range)			
	100 Ω	\pm (2% of reading + 0.5% of range) / \pm (0.5% of reading + 0.05% of range)			
	1k Ω	\pm (2% of reading + 0.5% of range) / \pm (0.5% of reading + 0.05% of range)			
	10k Ω	\pm (2% of reading + 0.5% of range) / \pm (0.5% of reading + 0.05% of range)			
100k Ω	\pm (2% of reading + 0.5% of range) / \pm (0.5% of reading + 0.05% of range)				
Flashover Detection					
Setting Mode	Programmable setting				
Detection Current	AC : 1mA ~ 15mA, DC : 1mA ~ 10mA				
Secure Protection Function					
Fast Output Cut-off	0.4ms after NG happen				
Ground Fault Interrupt	0.5mA \pm 0.25mA AC, ON/OFF				
Panel Operation Lock	Present password				
Interlock	YES				
GO/NG Judgment Window					
Indication, Alarm	GO : Short sound, Green LED; NG : Long sound, Red LED				
Data Hold	Least tests data memories				
Memory Storage	50 instrument setups with up to 20 test steps				
Interface	RS232*1 (Standard), RS232*1 or GPIB & Handler & Temperature interface (Optional).				
General					
Operation Environment	Temperature: 0 $^{\circ}$ C ~ 45 $^{\circ}$ C, Humidity: 15% to 95% R.H@ \leq 40 $^{\circ}$ C				
Power Consumption	500VA				
Power Requirements	90~132Vac or 198~264Vac, 47~66Hz				
Weight	Approx.20kg				

All specifications are subject to change without notice. Please visit our website for the most up to date specifications.

ORDERING INFORMATION

19035 : Wound Component EST Tester

A190345 : High Voltage cable for Impulse Winding Tester Connection

A190346 : RS232 cable for Impulse Winding Tester Connection

A190347 : GPIB & Handler & Temperature Interface

A190348 : RS232 Interface

A190351 : 8ch-16ch HV box for 19035

A190358 : Handler Indicator

A190359 : 16ch HV External Scanning Box

A190512 : Auto Control TR. Scan Box(3002B)

A190702 : 40KV HV Test Probe

Developed and Manufactured by :

CHROMA ATE INC.

致茂電子股份有限公司

HEADQUARTERS

No. 66, Hwa-Ya 1st Rd.,

Hwa-Ya Technology Park,

Kuei-Shan Hsiang, 33383

Taoyuan County, Taiwan

Tel: +886-3-327-9999

Fax: +886-3-327-8898

http://www.chromaate.com

E-mail: info@chromaate.com

CHINA

CHROMA ELECTRONICS

(SHENZHEN) CO., LTD.

8F, No.4, Nanyou Tian An

Industrial Estate, Shenzhen,

China PC: 518052

Tel: +86-755-2664-4598

Fax: +86-755-2641-9620

JAPAN

CHROMA JAPAN CORP.

472 Nippa-cho, Kouhoku-ku,

Yokohama-shi, Kanagawa,

223-0057 Japan

http://www.chroma.co.jp

E-mail: info@chromaate.com

U.S.A.

CHROMA SYSTEMS

SOLUTIONS, INC.

25612 Commercentre Drive,

Lake Forest, CA 92630-8830

Tel: +1-949-600-6400

Fax: +1-949-600-6401

Toll Free: +1-866-600-6050

http://www.chromausa.com

E-mail: sales@chromausa.com

EUROPE

CHROMA ATE EUROPE B.V.

Morsestraat 32, 6716 AH Ede,

The Netherlands

Tel: +31-318-648282

Fax: +31-318-648288

http://www.chroma.eu.com

E-mail: sales@chroma.eu.com

Distributed by:



Septiembre 31. 28022 Madrid
Tel. 91 300 0191 Fax. 31 388 5433
idm@idm-instrumentos.es
www.idm-instrumentos.es